



# 12-02 ELITE top mouldings notes

## **NOTES**

# ELITE top mouldings 12-03 crowns

CROWN MOULDING

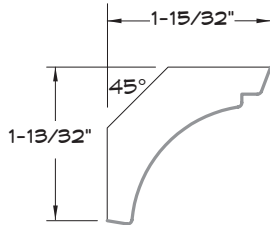

ABBREVIATION

MCR100119

RISE	1 3/8"
RAKE	1 7/16"

CROWN MOULDING

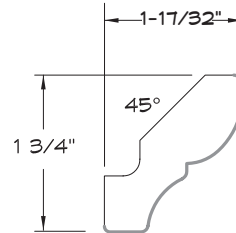

ABBREVIATION

MCR100940

RISE	1 3/4"
RAKE	1 1/2"

CROWN MOULDING

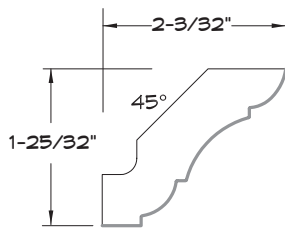

ABBREVIATION

MCR100146

RISE	1 13/16"
RAKE	2 1/8"

CROWN MOULDING

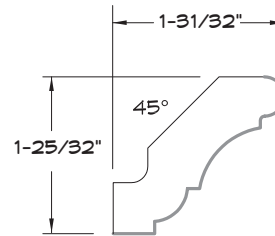

ABBREVIATION

MCR100844

RISE	1 13/16"
RAKE	1 15/16"

CROWN MOULDING

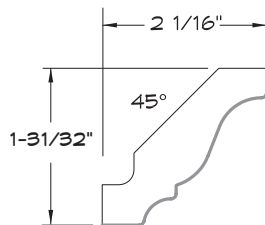

ABBREVIATION

MCR100942

RISE	1 15/16"
RAKE	2 1/16"

CROWN MOULDING

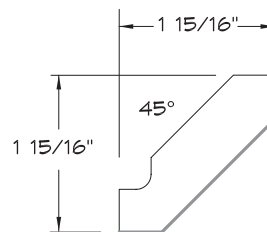

ABBREVIATION

MCR101672

RISE	1 15/16"
RAKE	1 15/16"

CROWN MOULDING

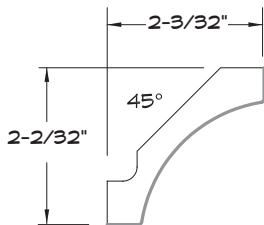

ABBREVIATION

MCR100383

RISE	2 1/16"
RAKE	2 1/16"

CROWN MOULDING

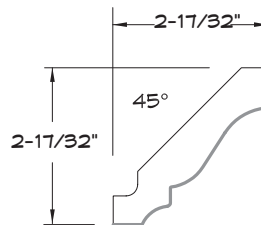

ABBREVIATION

MCR100155

RISE	2 9/16"
RAKE	2 1/2"

# 12-04 ELITE top mouldings crowns

CROWN MOULDING

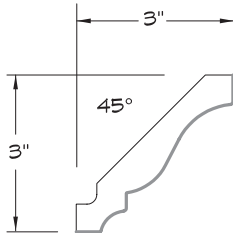

ABBREVIATION

MCR101160

RISE	3"
RAKE	3"

CROWN MOULDING

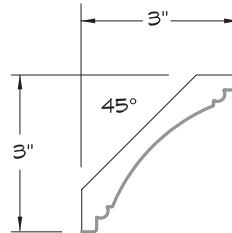

ABBREVIATION

MCR101346

RISE	3"
RAKE	3"

CROWN MOULDING

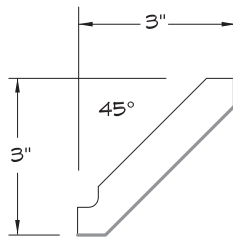

ABBREVIATION

MCR101673

RISE	3"
RAKE	3"

CROWN MOULDING

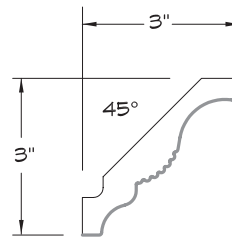

ABBREVIATION

MCR101731

RISE	3"
RAKE	3"

CROWN MOULDING

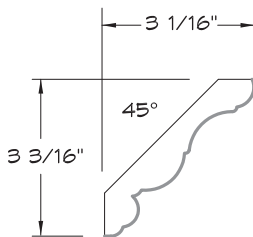

ABBREVIATION

MCR102089

RISE	3 3/16"
RAKE	3 1/16"

CROWN MOULDING

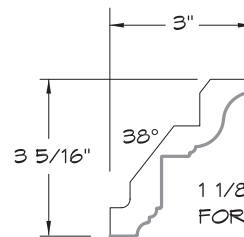

ABBREVIATION

MCR102803

RISE	3 5/16"
RAKE	3"

1 1/8" x 5/8" NOTCH  
FOR INSERT MOULDING

CROWN MOULDING

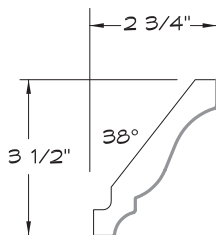

ABBREVIATION

MCR102248

RISE	3 1/2"
RAKE	2 3/4"

CROWN MOULDING

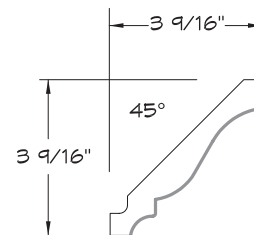

ABBREVIATION

MCR100208

RISE	3 9/16"
RAKE	3 9/16"

# ELITE top mouldings 12-05 crowns

CROWN MOULDING

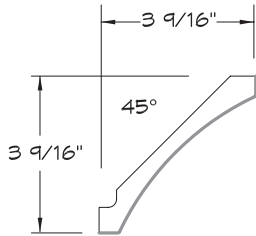

ABBREVIATION

MCR100983

RISE	3 9/16"
RAKE	3 9/16"

CROWN MOULDING

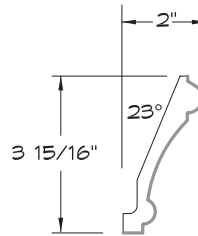

ABBREVIATION

MCR102802

RISE	3 15/16"
RAKE	2"

CROWN MOULDING

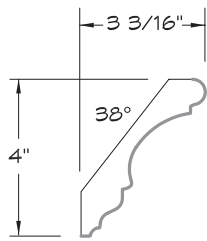

ABBREVIATION

MCR102253

RISE	4"
RAKE	3 3/16"

CROWN MOULDING

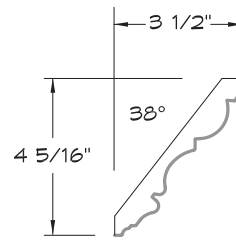

ABBREVIATION

MCR101615

RISE	4 5/16"
RAKE	3 1/2"

CROWN MOULDING

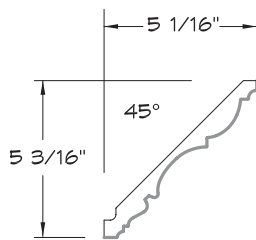

ABBREVIATION

MCR102258

RISE	5 3/16"
RAKE	5 1/16"

CROWN MOULDING

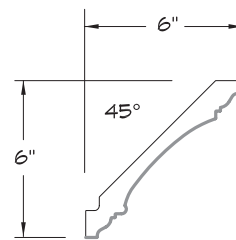

ABBREVIATION

MCR102801

RISE	6"
RAKE	6"

CROWN MOULDING

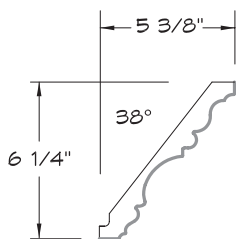

ABBREVIATION

MCR102252

RISE	6 1/4"
RAKE	5 3/8"

CROWN MOULDING

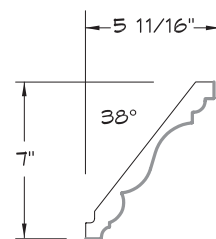

ABBREVIATION

MCR101293

RISE	7"
RAKE	5 11/16"

# 12-06 ELITE top mouldings crowns with returns

CROWN MOULDING

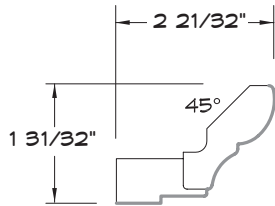

ABBREVIATION

MCR100941

RISE	1 3/4"
RAKE	1 1/2"

CROWN MOULDING

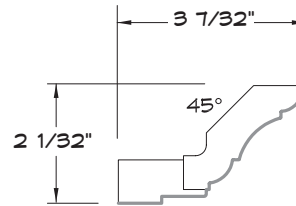

ABBREVIATION

MCR100120

RISE	1 13/16"
RAKE	2 1/8"

CROWN MOULDING

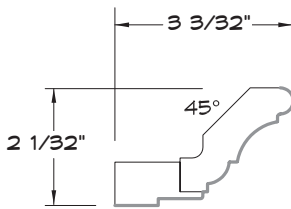

ABBREVIATION

MCR100848

RISE	1 13/16"
RAKE	1 15/16"

CROWN MOULDING

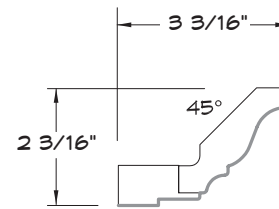

ABBREVIATION

MCR100943

RISE	1 13/16"
RAKE	2 1/16"

CROWN MOULDING

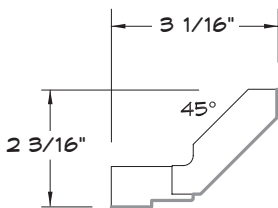

ABBREVIATION

MCR101696

RISE	1 15/16"
RAKE	1 15/16"

CROWN MOULDING

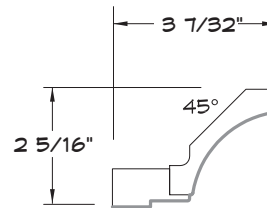

ABBREVIATION

MCR100389

RISE	2 1/16"
RAKE	2 1/16"

CROWN MOULDING

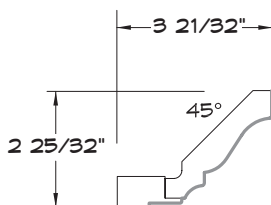

ABBREVIATION

MCR100850

RISE	2 1/16"
RAKE	2 1/2"

CROWN MOULDING

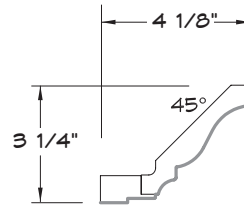

ABBREVIATION

MCR101192

RISE	3"
RAKE	3"

# ELITE top mouldings 12-07 crowns with returns

CROWN MOULDING

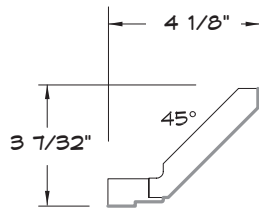

ABBREVIATION  
MCR101697

RISE	3"
RAKE	3"

CROWN MOULDING

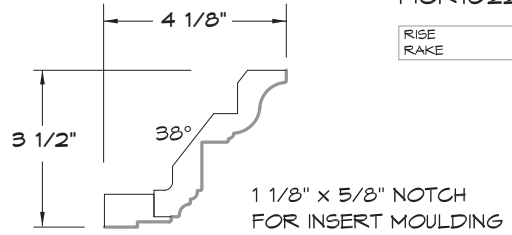

ABBREVIATION  
MCR102264

RISE	3 5/16"
RAKE	3"

CROWN MOULDING

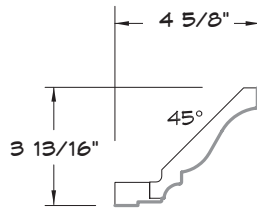

ABBREVIATION  
MCR101024

RISE	3 9/16"
RAKE	3 1/2"

CROWN MOULDING

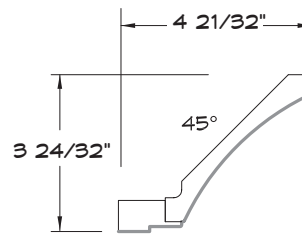

ABBREVIATION  
MCR101045

RISE	3 9/16"
RAKE	3 9/16"

CROWN MOULDING

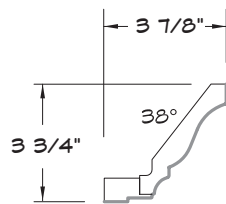

ABBREVIATION  
MCR102267

RISE	3 5/8"
RAKE	2 3/4"

CROWN MOULDING

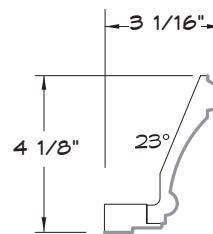

ABBREVIATION  
MCR102807

RISE	2"
RAKE	3 15/16"

3 7/8"

# 12-08 ELITE top mouldings insert crown

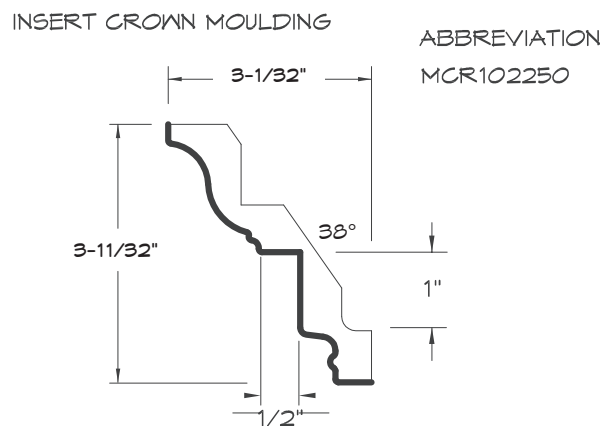
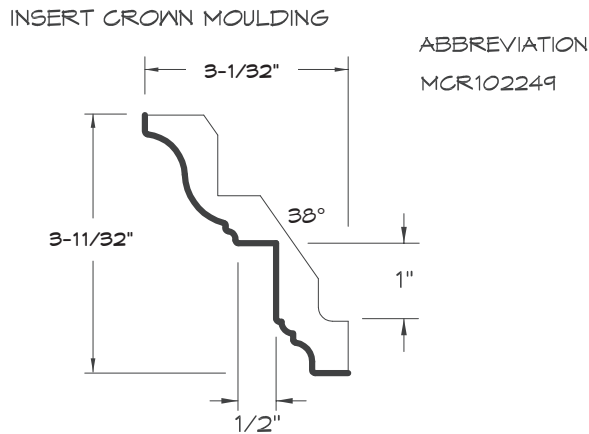
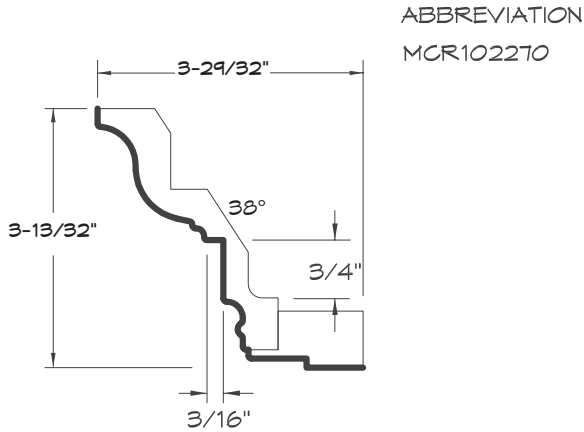

EGG AND DART  
MOULDING  
ABBREVIATION  
MED101163

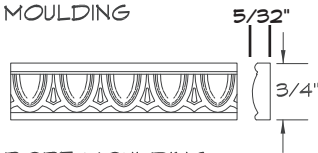

ROPE MOULDING  
ABBREVIATION  
MRO100810

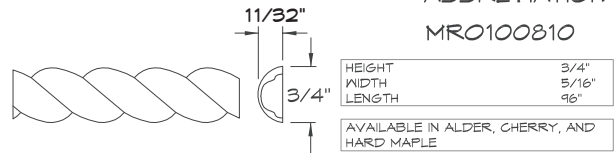

ROPE MOULDING  
ABBREVIATION  
MRO100811

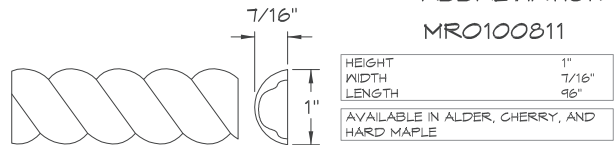

DENTIL MOULDING  
ABBREVIATION  
MDE101239

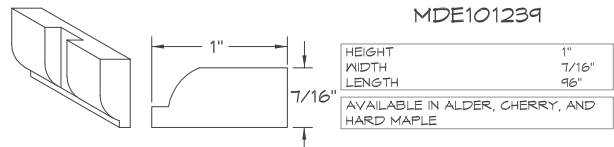

DENTIL MOULDING  
ABBREVIATION  
MDE101238

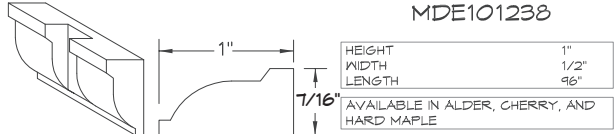

DENTIL MOULDING  
ABBREVIATION  
MDE100829

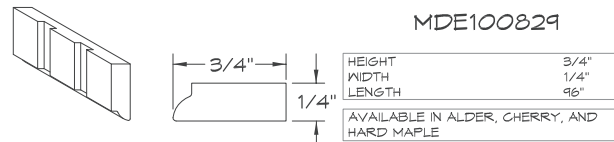

MOULDING  
ABBREVIATION  
MSC101741

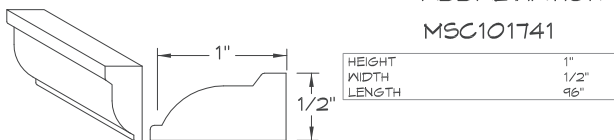

SCRIBE MOULDING  
ABBREVIATION  
MSC101928

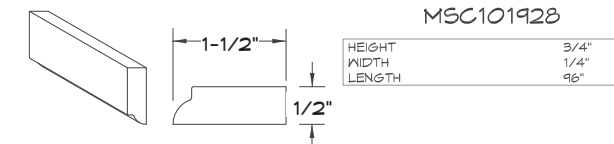



# ELITE mid mouldings light rail, cap

12-09

LIGHT RAIL  
MOULDING

ABBREVIATION  
MLR01962-A

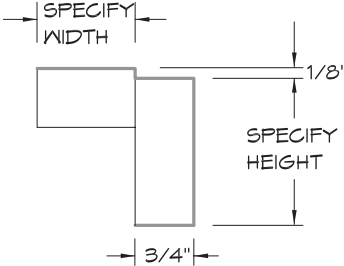

LIGHT RAIL  
MOULDING

ABBREVIATION  
MLR01962-B

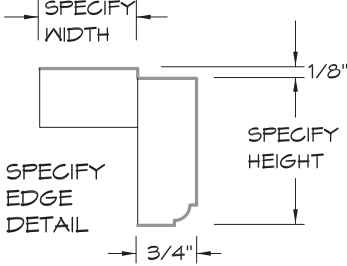

LIGHT RAIL  
MOULDING

ABBREVIATION  
MLR01962-C

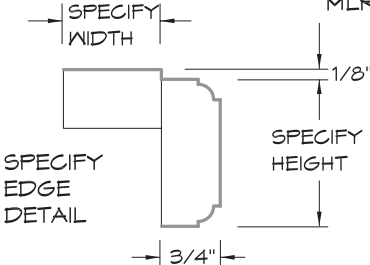

LIGHT RAIL  
MOULDING

ABBREVIATION  
MLR01962-D

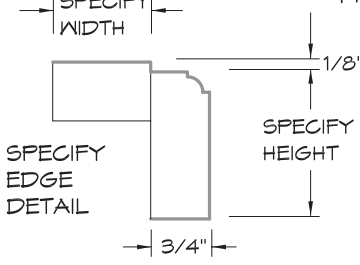

CAP MOULDING

ABBREVIATION  
MCP01960-A

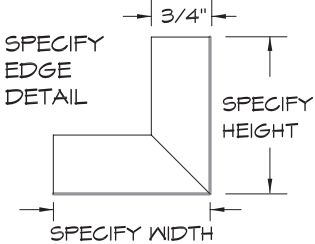

CAP MOULDING

ABBREVIATION  
MCP01960-B

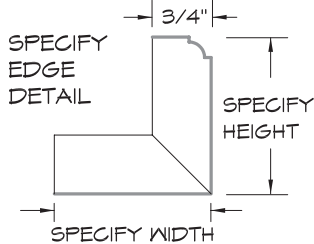

CAP MOULDING

ABBREVIATION  
MCP01960-C

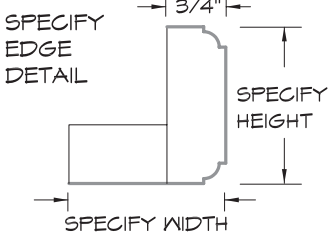

CAP MOULDING

ABBREVIATION  
MCP01960-D

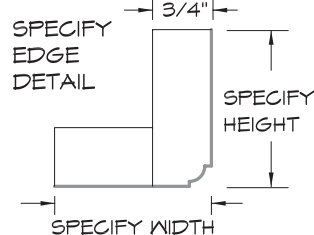

# 12-10 ELITE mid mouldings cap, chair rail

CAP MOULDING

ABBREVIATION  
MCP100967

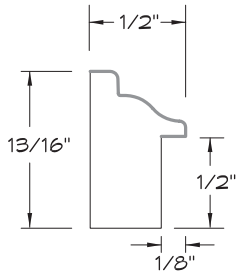

CAP MOULDING

ABBREVIATION  
MCP101016

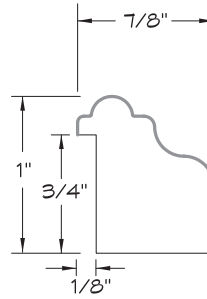

CAP MOULDING

ABBREVIATION  
MCP101091

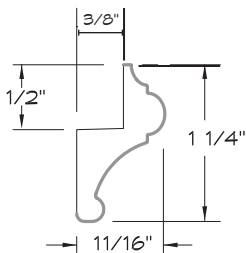

CAP MOULDING

ABBREVIATION  
MCP100126

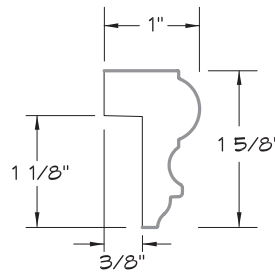

CAP MOULDING

ABBREVIATION  
MCP1000952

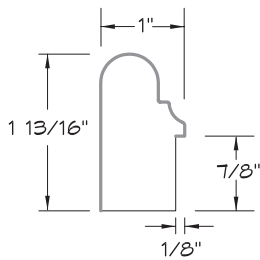

RISER MOULDING

ABBREVIATION  
MRI001961

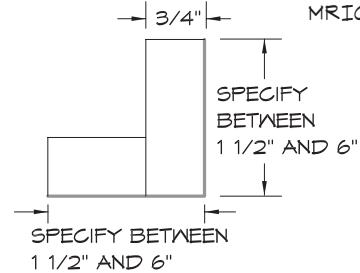

CHAIR RAIL  
MOULDING

ABBREVIATION  
MCH100156

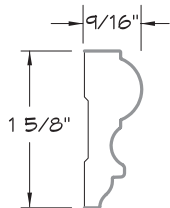

CHAIR RAIL  
MOULDING

ABBREVIATION  
MCH100125

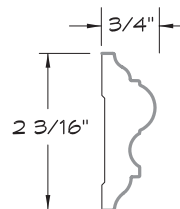

# ELITE mid mouldings under/over cabinet

12-11

UNDER/OVER  
CABINET MOULDING

ABBREVIATION  
MUO101773

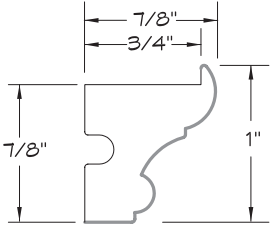

UNDER/OVER  
CABINET MOULDING

ABBREVIATION  
MUO102078

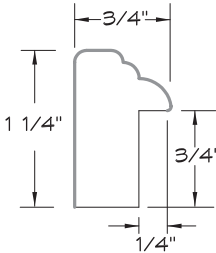

UNDER/OVER  
CABINET MOULDING

ABBREVIATION  
MUO101017

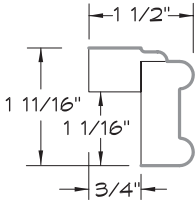

UNDER/OVER  
CABINET MOULDING

ABBREVIATION  
MUO101018

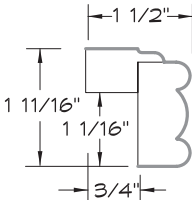

UNDER/OVER  
CABINET MOULDING

ABBREVIATION  
MUO100200

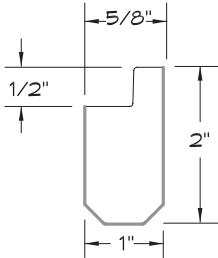

UNDER/OVER  
CABINET MOULDING

ABBREVIATION  
MUO100205

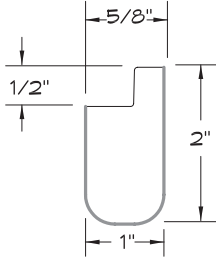

UNDER/OVER  
CABINET MOULDING

ABBREVIATION  
MUO100916

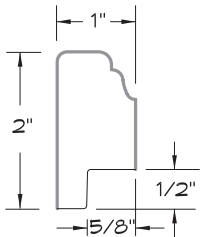

UNDER/OVER  
CABINET MOULDING

ABBREVIATION  
MUO101011

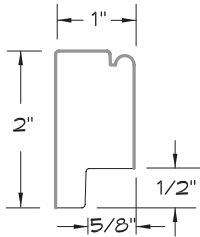

# 12-12 ELITE mid mouldings under/over cabinet

UNDER/OVER  
CABINET MOULDING

ABBREVIATION  
MUO101034

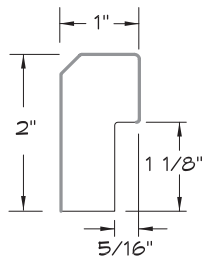

UNDER/OVER  
CABINET MOULDING

ABBREVIATION  
MUO101997

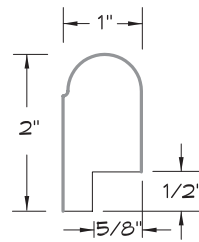

UNDER/OVER  
CABINET MOULDING

ABBREVIATION  
MUO101019

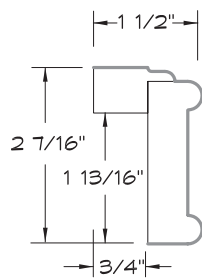

ELITE mid mouldings  
casing/base

12-13

CASING MOULDING

ABBREVIATION  
MCA100927

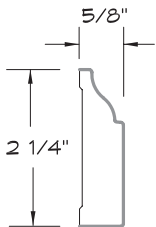

CASING MOULDING

ABBREVIATION  
MCA101098

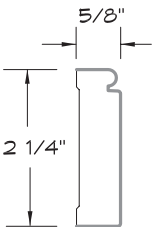

CASING MOULDING

ABBREVIATION  
MCA101102

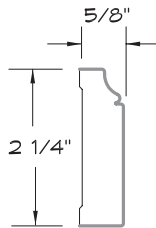

CASING MOULDING

ABBREVIATION  
MCA100928

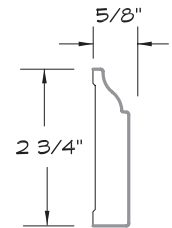

CASING MOULDING

ABBREVIATION  
MCA101097

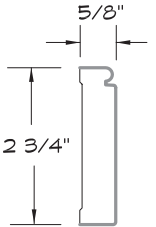

CASING MOULDING

ABBREVIATION  
MCA101101

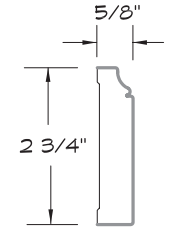

CASING MOULDING

ABBREVIATION  
MCA101828

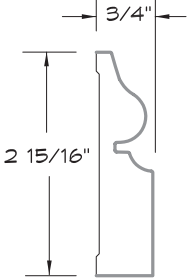

CASING MOULDING

ABBREVIATION  
MCA100929

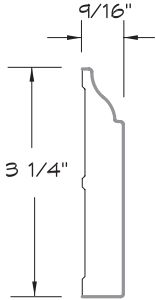

# 12-14 ELITE mid mouldings casing/furniture base

CASING MOULDING

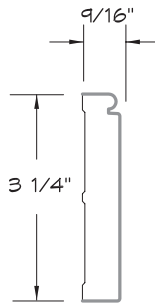

ABBREVIATION  
MCA101096

CASING MOULDING

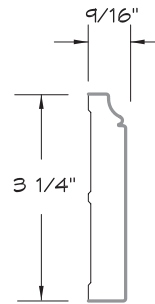

ABBREVIATION  
MCA101100

CASING MOULDING

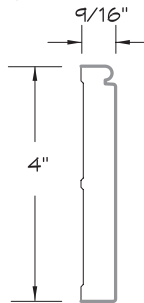

ABBREVIATION  
MCA101231

CASING MOULDING

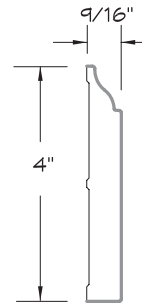

ABBREVIATION  
MCA101233

CASING MOULDING

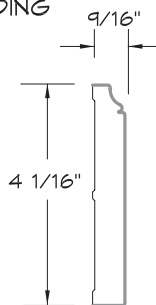

ABBREVIATION  
MCA101232

CASING MOULDING

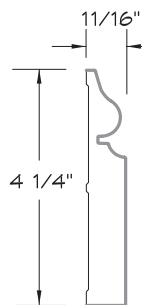

ABBREVIATION  
MCA101316

CASING MOULDING

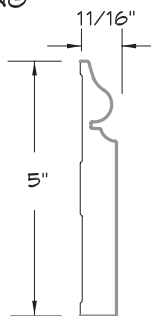

ABBREVIATION  
MCA101848

CASING MOULDING

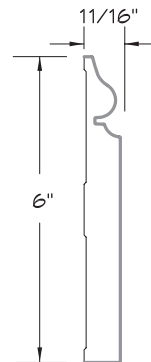

ABBREVIATION  
MCA101847

ELITE mid mouldings  
under/over cabinet

12-15

WINDOW SILL  
MOULDING

ABBREVIATION  
MWS101783

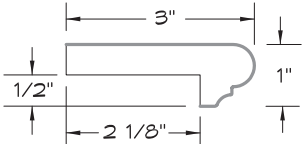

WINDOW SILL  
MOULDING

ABBREVIATION  
MWS101784

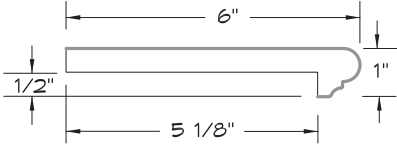

# 12-16 ELITE trim mouldings cove

COVE MOULDING

ABBREVIATION  
MCO100108

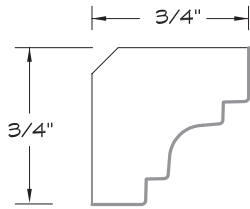

COVE MOULDING

ABBREVIATION  
MCO100398

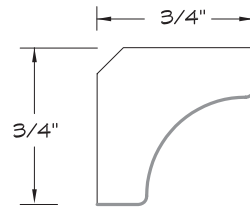

COVE MOULDING

ABBREVIATION  
MCO101093

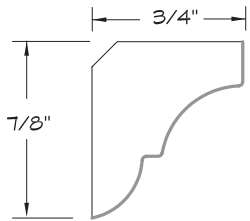

COVE MOULDING

ABBREVIATION  
MCO100128

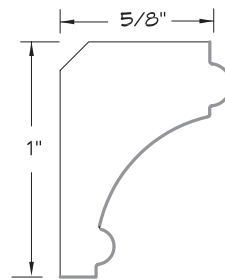



# ELITE trim mouldings 12-17

column, fluted column, 45° corner filler, 90° corner filler

COLUMN MOULDING

ABBREVIATION  
MCM101047

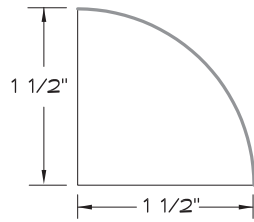

COLUMN MOULDING

ABBREVIATION  
MCM102283

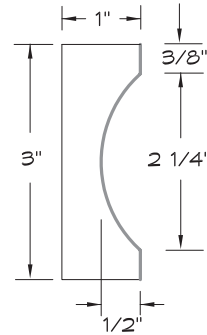

FLUTED COLUMN MOULDING

ABBREVIATION  
MCM100979

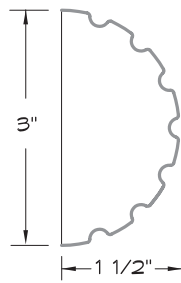

45° CORNER FILLER

ABBREVIATION  
MCF101292

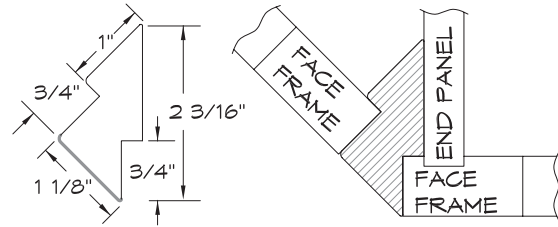

90° CORNER FILLER

ABBREVIATION  
MCF101788

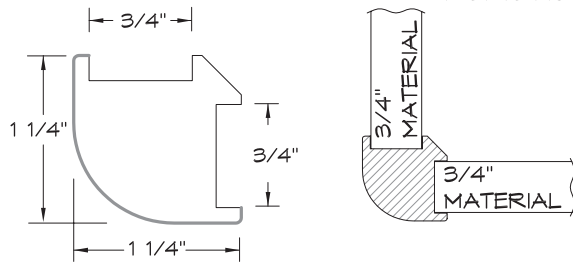

90° CORNER FILLER

ABBREVIATION  
MCF101937

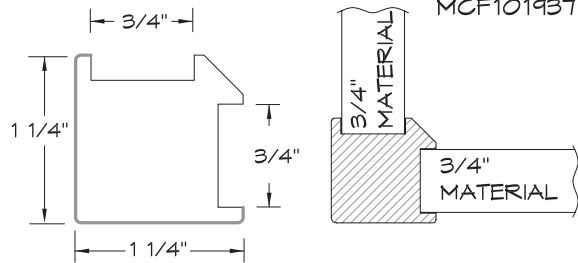

# 12-18 ELITE trim mouldings

## astragal, inside corner molding, corner block transition

ASTRAGAL MOULDING

ABBREVIATION  
MAS101144

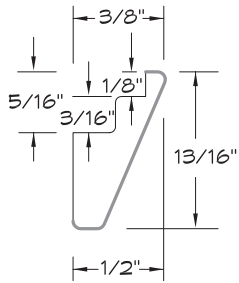

ASTRAGAL MOULDING

ABBREVIATION  
MAS100992

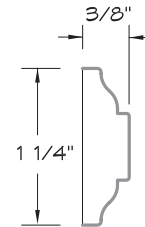

ASTRAGAL MOULDING

ABBREVIATION  
MAS100993

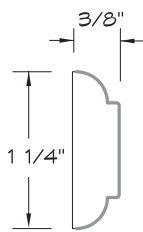

ASTRAGAL MOULDING

ABBREVIATION  
MAS100996

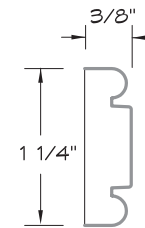

INSIDE CORNER  
MOULDING  
# MIC100108

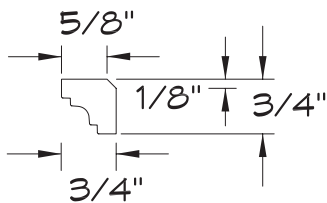

CORNER BLOCK TRANSITION  
MOULDING # MTB000CBT

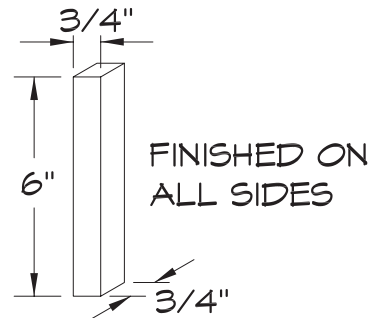

# ELITE trim mouldings 12-19

## outside corner

OUTSIDE CORNER  
MOULDING

ABBREVIATION  
MOC100114

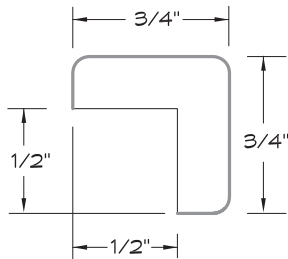

OUTSIDE CORNER  
MOULDING

ABBREVIATION  
MOC101279

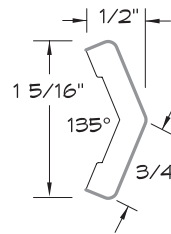

OUTSIDE CORNER  
MOULDING

ABBREVIATION  
MOC100115

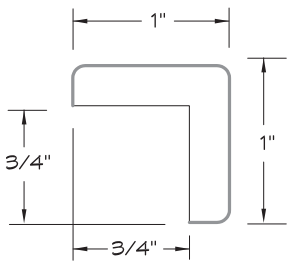

OUTSIDE CORNER  
MOULDING

ABBREVIATION  
MOC101310

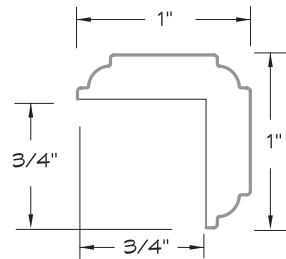

OUTSIDE CORNER  
MOULDING

ABBREVIATION  
MOC101227

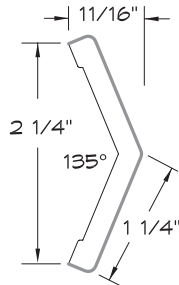

OUTSIDE CORNER  
MOULDING

ABBREVIATION  
MOC101309

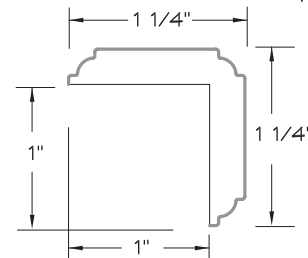

OUTSIDE CORNER  
MOULDING

ABBREVIATION  
MOC102226

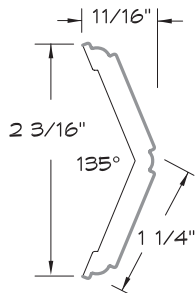

# 12-20 ELITE trim mouldings applied

APPLIED MOULDING

ABBREVIATION  
MAP100808

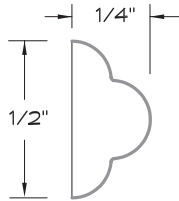

APPLIED MOULDING

ABBREVIATION  
MAP100387

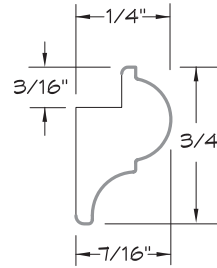

APPLIED MOULDING

ABBREVIATION  
MAP100818

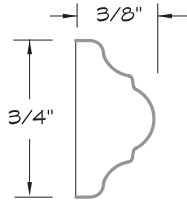

APPLIED MOULDING

ABBREVIATION  
MAP100922

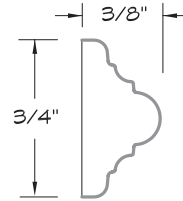

APPLIED MOULDING

ABBREVIATION  
MAP100102

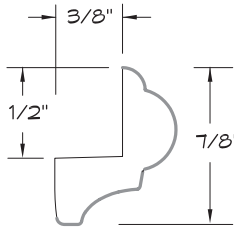

APPLIED MOULDING

ABBREVIATION  
MAP100807

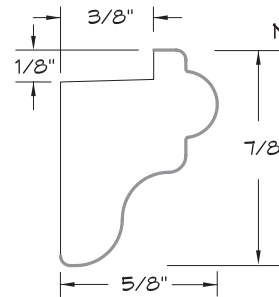

APPLIED MOULDING

ABBREVIATION  
MAP100881

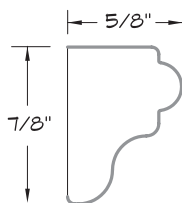

APPLIED MOULDING

ABBREVIATION  
MAP100827

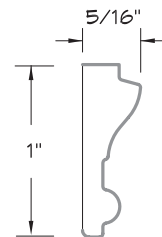

ELITE trim mouldings 12-21  
outside corner

APPLIED MOULDING

ABBREVIATION  
MAP101094

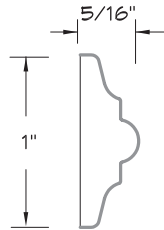

APPLIED MOULDING

ABBREVIATION  
MAP101114

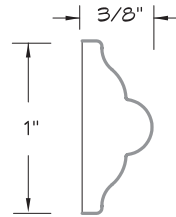

APPLIED MOULDING

ABBREVIATION  
MAP101138

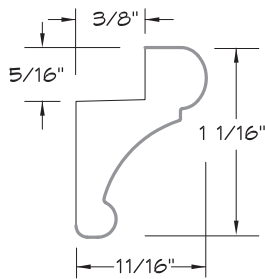

APPLIED MOULDING

ABBREVIATION  
MAP100101

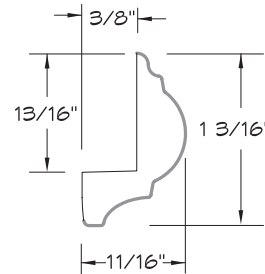

APPLIED MOULDING

ABBREVIATION  
MAP101041

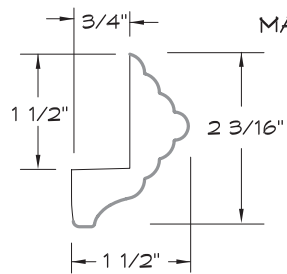

# 12-22 ELITE trim mouldings bead

BEAD MouldING

ABBREVIATION  
MBE100831

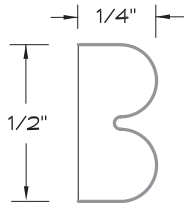

BEAD MouldING

ABBREVIATION  
MBE101079

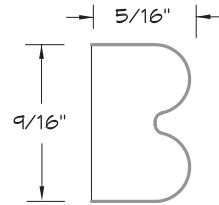

BEAD MouldING

ABBREVIATION  
MBE100825

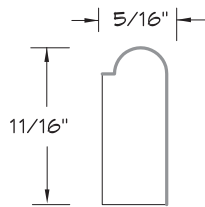

BEAD MouldING

ABBREVIATION  
MBE100832

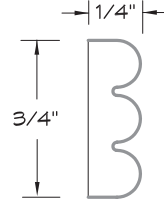

BEAD MouldING

ABBREVIATION  
MBE101012

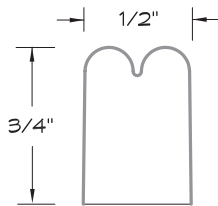

BEAD MouldING

ABBREVIATION  
MBE100833

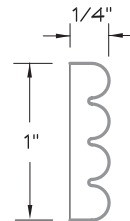

SCRIBE MOULDING

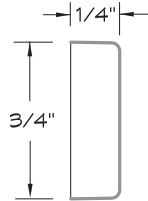

ABBREVIATION  
MSC100147

SCRIBE MOULDING

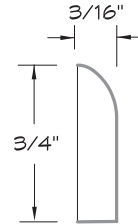

ABBREVIATION  
MSC100310

SCRIBE MOULDING

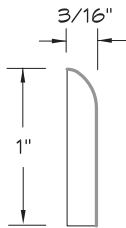

ABBREVIATION  
MSC101844

# 12-24 ELITE trim mouldings bead

ROPE MOULDING

ABBREVIATION  
MRO101015

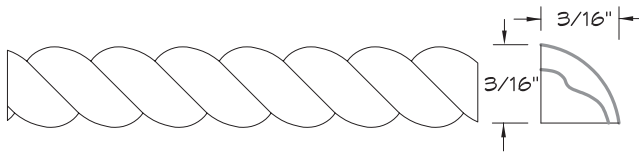

ROPE MOULDING

ABBREVIATION  
MRO101169

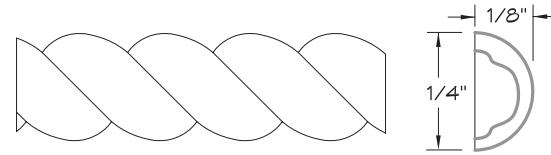



# ELITE trim mouldings 12-25

## dentil, rope

DENTIL MOULDING

ABBREVIATION  
MDE100829

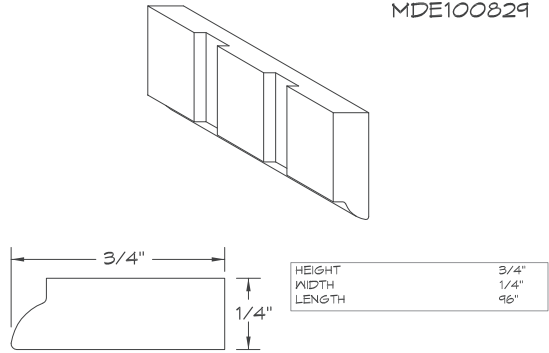

ROPE MOULDING

ABBREVIATION  
MRO100811

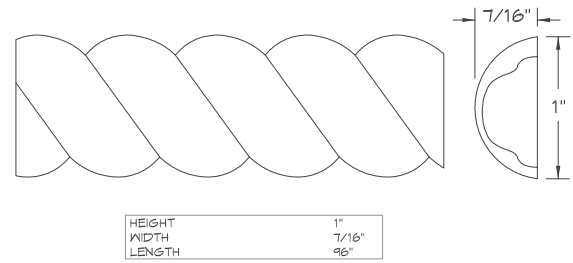

DENTIL MOULDING

ABBREVIATION  
MDE101239

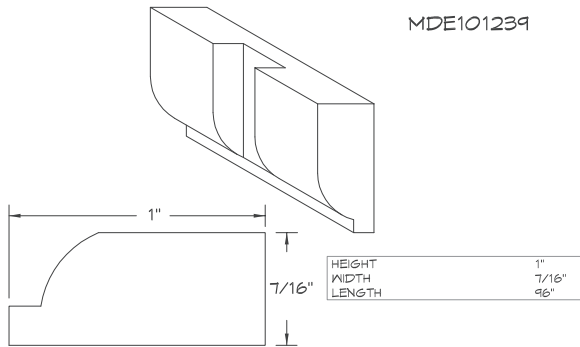

ROPE MOULDING

ABBREVIATION  
MRO100810

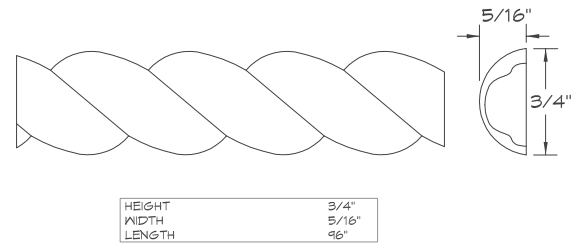

DENTIL MOULDING

ABBREVIATION  
MDE101238

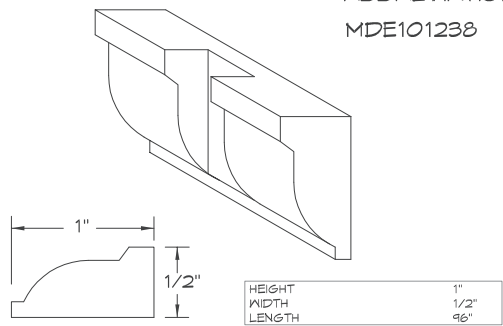

ROPE MOULDING

ABBREVIATION  
MRO100809

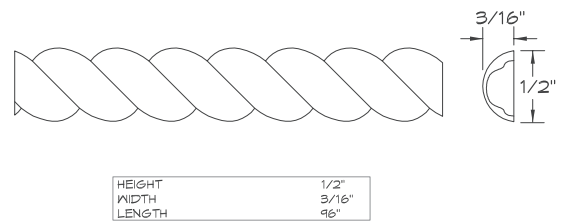

# 12-26 ELITE trim mouldings face, egg and dart, scribe

MOULDING

ABBREVIATION  
MSC101741

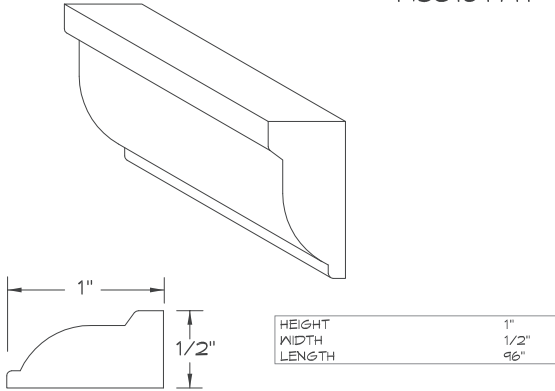

EGG AND DART  
MOULDING

ABBREVIATION  
MED101163

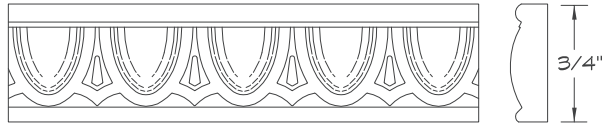

FACE MOULDING

ABBREVIATION  
MFA100930

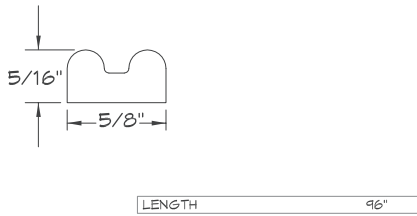

SCRIBE MOULDING

ABBREVIATION  
MSC100972

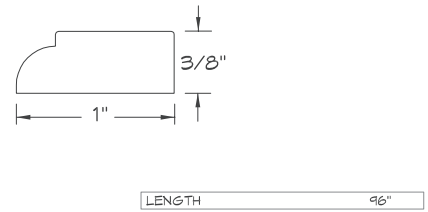

FACE MOULDING

ABBREVIATION  
MFA101866

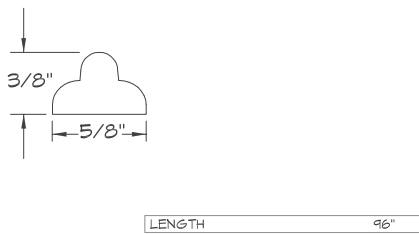

SCRIBE MOULDING

ABBREVIATION  
MSC101928

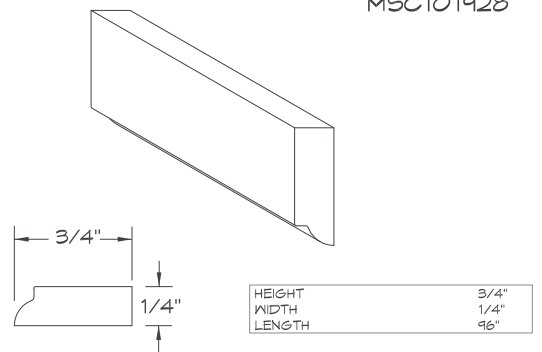

ELITE trim mouldings  
dentil, quarter round, retainer

12-27

DENTIL MOULDING

ABBREVIATION  
MDE100829

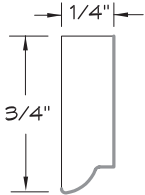

QUARTER ROUND  
MOULDING

ABBREVIATION  
MQR100110

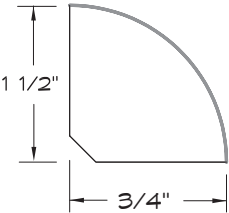

RETAINER MOULDING

ABBREVIATION  
MRE101120

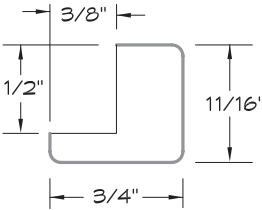

RETAINER MOULDING

ABBREVIATION  
MRE101036

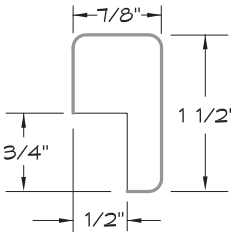

# 12-28 mouldings furniture base, base shoe

BASE MOULDING

ABBREVIATION  
MBA100960

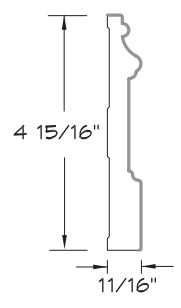

BASE MOULDING

ABBREVIATION  
MBA101847

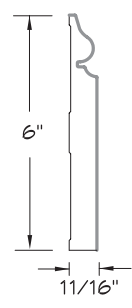

BASE SHOE  
MOULDING

ABBREVIATION  
MRBS100112

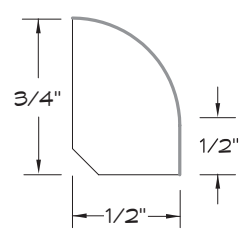

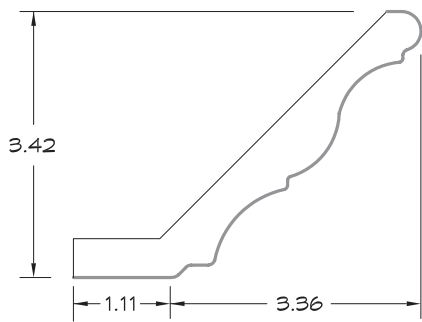

DESIGNER CROWN 1305

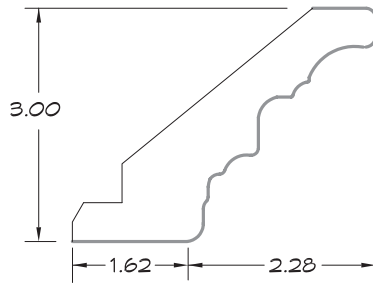

REGAL CROWN 1306

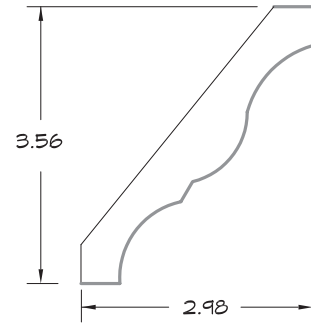

ROYAL CROWN 1309

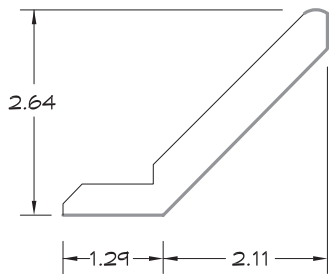

STRAIGHT CROWN 85024

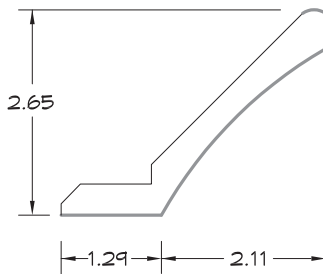

COVE CROWN 85023

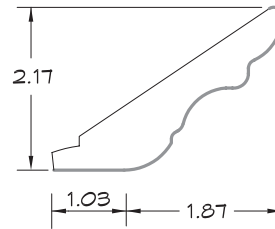

COLONY CROWN 1304

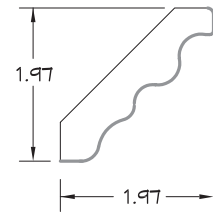

WINDSOR CROWN 1307

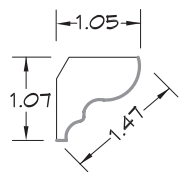

SOFFIT CROWN 1310

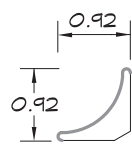

COVE 1405

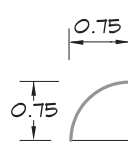

SHOE 1410

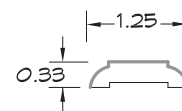

BATTEN 1406

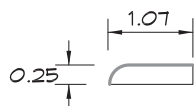

SCRIBE 1408

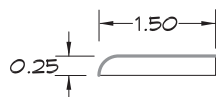

SCRIBE 85022

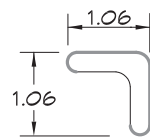

OUTSIDE CORNER 1407

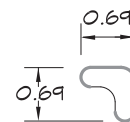

OUTSIDE CORNER 1116

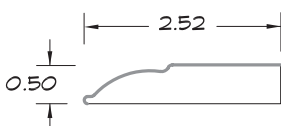

BASE 1308



BASE 8409

12-30 mouldings  
notes

## NOTES

YOU-DESIGN-IT CUSTOM SOLID STOCK ORDER FORM

THICKNESS 3/4"  
WIDTH \_\_\_\_\_ (BETWEEN 1" AND 6")  
LENGTH 96" (90" USEABLE)

A	_____	FACE
B	_____	LEFT SIDE
C	_____	RIGHT SIDE
D	_____	BACK (INCREASED CHARGES)
1	_____	LEFT TOP EDGE*
2	_____	RIGHT TOP EDGE*
3	_____	RIGHT BOTTOM EDGE*
4	_____	LEFT BOTTOM EDGE*

\* 14 EDGE CHOICES

QUANTITY \_\_\_\_\_

DRAWING WILL BE SENT WITH ACKNOWLEDGEMENT

# 12-32 You-Design-It moulding moulding part choices

## YOU-DESIGN-IT CUSTOM SOLID STOCK

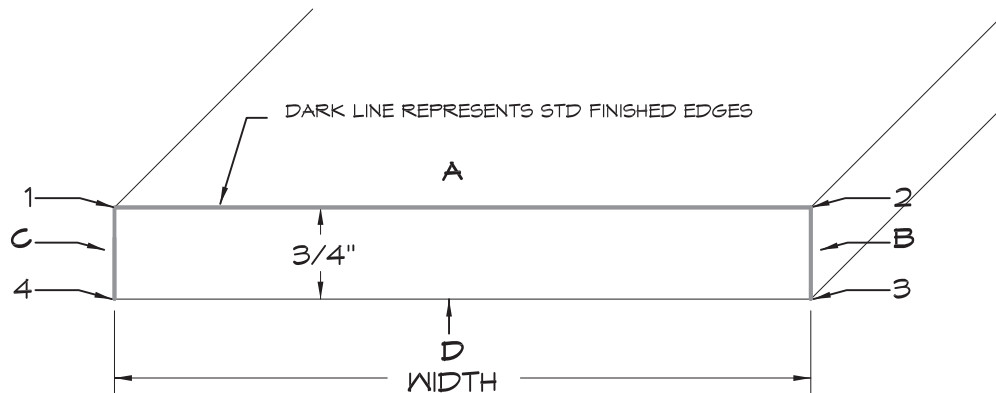

- |   |            |                |
|---|------------|----------------|
| A | FACE       | _____          |
| B | LEFT SIDE  | _____          |
| C | RIGHT SIDE | _____          |
| D | BACK*      | ___ YES ___ NO |

\* FINISH IS OPTIONAL (INCREASED CHARGES APPLY)

### STD EDGE IS SQUARE (D7)\*\*

\*\* SPECIFY OPTIONAL EDGES

SEE FOLLOWING PAGE FOR OPTIONAL EDGE PROFILES  
(INCREASED CHARGES APPLY)

- |   |                   |       |
|---|-------------------|-------|
| 1 | LEFT TOP EDGE     | _____ |
| 2 | RIGHT TOP EDGE    | _____ |
| 3 | RIGHT BOTTOM EDGE | _____ |
| 4 | LEFT BOTTOM EDGE  | _____ |

### FINISHED SURFACES

- |           |                                  |
|-----------|----------------------------------|
| THICKNESS | 3/4"                             |
| WIDTH     | SPECIFY BETWEEN 1" AND 6"***     |
|           | *** OVER 3" MAY HAVE GLUE UP LIN |
| LENGTH    | 96" (90" USEABLE)                |



YOU-DESIGN-IT CUSTOM SOLID STOCK

EXAMPLE

	THICKNESS	3/4"
	WIDTH	4"
	LENGTH	96"
A	FACE	STD
B	LEFT SIDE	STD
C	RIGHT SIDE	STD
D	BACK	___ YES X NO
1	LEFT TOP EDGE	D18
2	RIGHT TOP EDGE	D7
3	RIGHT BOTTOM EDGE	D7
4	LEFT BOTTOM EDGE	D18

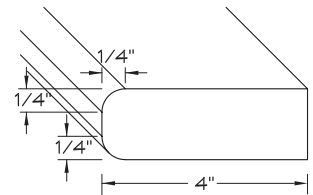

DRAWING WILL COME WITH ACKNOWLEDGEMENT

OPTIONAL EDGE PROFILES

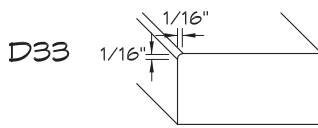
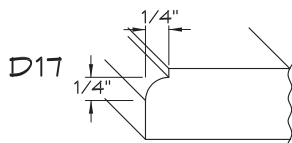
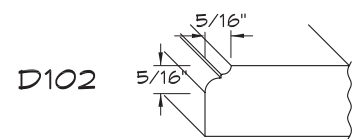
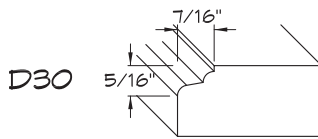
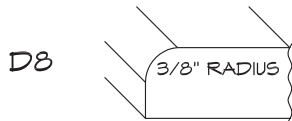
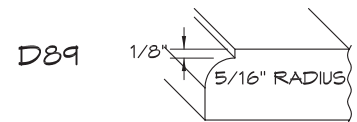
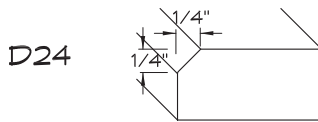
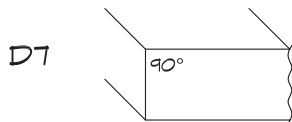

D202  
1/4" BEAD

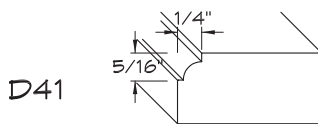
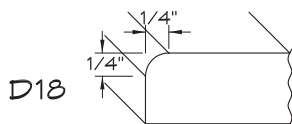
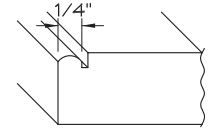

D203  
3/8" BEAD

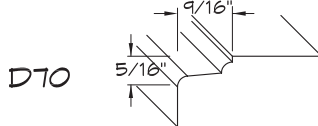
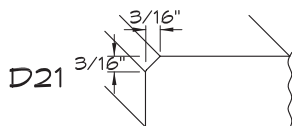
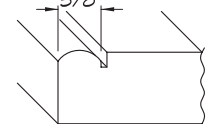

12-34 specialty mouldings  
notes

## NOTES

## Vendors

Ovation is partnering with the following vendors, all of which have done a great job of giving you the information that you will need for specifying their fine products, either on their websites or in their catalogs. Ovation will only list part numbers and woods available as standard by the vendor. Please note that there are both standard/stock and premium/non-stock wood offerings. Only the standard selections will be in OPTS; premium wood selections will require a quote from customer service.

In Ovation's catalog, most but not all of these offerings are listed. If it's not listed in OPTS, please contact customer service for a quote.

**ART FOR EVERYDAY** Inc.

[www.artforeveryday.com](http://www.artforeveryday.com)

 **BWI.**  
Brown Wood, Inc.

[www.brownwoodinc.com](http://www.brownwoodinc.com)

**Enkeboll**  
D E S I G N S

[www.shopenkebolldesigns.com](http://www.shopenkebolldesigns.com)

 **White River**

[www.whiteriver.com](http://www.whiteriver.com)

# 12-36 specialty mouldings

## Art for Everyday

All items are stocked in Alder, Cherry and Hard Maple.  
 Non-stock Woods: Black Walnut, Mahogany, Hickory, Red and White Oak (Premium upcharges)  
**NOTE:** Art for Everyday reserves the right to make design modifications without previous notice.

MANTELS	CORBELS	CORBELS	CORBELS	TURNINGS	TURNINGS	CROWNS
MTL-G1	CBL-RH4	CBL-NBR1	CBL-FF1	POST-JF1	POST-L2	CRN-SOR28.5
EXT-FLT2	CBL-RH3	CBL-CM3	CBL-FLT2	POST-B3	POST-L1	CRN-SOR34
EXT-S2	CBL-RS4	CBL-CM2	CBL-FLT1	POST-B2	POST-M3	CRN-SOR84
MTL-00	CBL-RS3	CBL-CM1	CBL-FA2	POST-B1	POST-M2	CRN-SOR90
MTL-01	CBL-TB4	CBL-VN3	CBL-SH3	POST-D3	POST-M1	CRN-SOR96
MTL-A0	CBL-TB3	CBL-VN2	CBL-SH2	POST-D2	POST-N3	CRN-STR28.5
MTL-A1	CBL-TB2	CBL-VN1	CBL-SH1	POST-D1	POST-N2	CRN-STR34
MTL-BEL48	CBL-TB1	CBL-ACF3	FB4	POST-F3	POST-N1	CRN-STR90
MTL-BEL54	CBL-TR6	CBL-FRA3	FB3	POST-F2	POST-O3	CRN-STR96
MTL-EXT1	CBL-TR5	CBL-FRA2	FB2	POST-F1	POST-O2	CRN-SOR27
MTL-FAC2	CBL-TR4	CBL-FRA1	<b>CAPITALS</b>	POST-K3	POST-O 1	CRN-SOR28 5/16
MTL-FAL2	CBL-TR3	CBL-AC4	CPL-A4	POST-K2		CRN-SOR29 1/8
MTL-FAL3	CBL-TR2	CBL-AC3	CPL-A3	POST-K1		CRN-SRT30
MTL-FGR1	CBL-TR1	CBL-AC2	CPL-A2	POST-RPL3		CRN-SRT36
MTL-FGR2	CBL-TR0	CBL-AC1	CPL-A1	POST-RPL2		CRN-SRT42 1/8
MTL-FLT2	CBL-TRH2	CBL-TCY2	CPL-ED4	POST-RPL1		CRN-SS48
MTL-FOL2	CBL-ML5	CBL-TCY1	<b>LEGS</b>	POST-RPR3		CRN-SS96
MTL-FOL3	CBL-ML4	CBL-NH2	LEG-B4	POST-RPR2		CRN-LT48
MTL-G0	CBL-ML3	CBL-NH1	LEG-B3	POST-RPR1		CRN-LT96
MTL-LF3	CBL-ANC24	CBL-NA3	LEG-A4	POST-R3		CRN-SL30
MTL-PO	CBL-ANF24	CBL-NA2	LEG-A3	POST-R2		CRN-SL48
MTL-P1	CBL-FR3	CBL-NA1	LEG-A2	POST-R1		CRN-SL96
MTL-S2	CBL-FR2	CBL-WA4	LEG-A1	POST-A3		CRN-OF27
	CBL-FR1	CBL-WA3	Q-AC6	POST-A2		CRN-OF28 5/16
	CBL-PN4	CBL-WA2	Q-LEG2R	POST-A1		CRN-OF29 1/8
<b>VANITIES</b>	CBL-PN3	CBL-OL3	Q-LEG2L	POST-G3		CRN-OF30
VAN-K2	CBL-PN2	CBL-OL2	Q-LEG4	POST-G2		CRN-OF34 1/2
VAN-K1	CBL-PNC4	CBL-OL1	Q-LEG4 1/2	POST-G1		CRN-OF36
VAN-KEXT	CBL-PNC3	CBL-NOL3	Q-LEG5	POST-E3		CRN-OF42 1/8
VAN-VM3	CBL-PNC2	CBL-NOL2	Q-LEG6	POST-E2		CRN-OF84
VAN-V3	BRC4	CBL-NOL1	Q-LEGV	POST-E1		CRN-OF90
VAN-EXT2	BRC3	CBL-OB2	<b>TURNINGS</b>	POST-H3		CRN-OF96
APL-BA24	BRC2	CBL-OB1	POST-AC3	POST-H2		CRN-RA
APL-BA38	BRB4	CBL-GB2	POST-AC2	POST-H1		
APL-BO26	BRB3	CBL-GB1	POST-AC1	POST-I3		
APL-BO40	BRB2	CBL-GR3	POST-ACS5	POST-I2		
VAN-BA	CBL-BR3	CBL-GR2	POST-GR3	POST-I1		
VAN-BO	CBL-BR2	CBL-GR1	POST-GR2	POST-LF3		
VAN-EXT1	CBL-BR1	CBL-FH3	POST-GR1	POST-LF2		
VAN-WBA	CBL-WBR3	CBL-FH2	POST-JF3	POST-LF1		
VAN-WBO	CBL-WBR2	CBL-FF3	POST-JF2	POST-L3		
	CBL-NBR2	CBL-FF2				

specialty mouldings 12-37  
Brown Wood

All items are stocked in Alder, Cherry and Hard Maple.  
 Non-stock Woods: Black Walnut, Mahogany, Hickory, Red and White Oak (Premium upcharges)  
**NOTE:** Brown Wood reserves the right to make design modifications without previous notice.

TURNING	TURNING	CORBELS	HALF ROUND	SPINDLE	FOOT
000210	200310	600010	481010	311010	702022
000310	210210	600020	481030	311510	702510
030210	220210	600535	481510	312010	703510
030310	220260	601001	481520	321010	704010
050210	220270	601535	481530	321510	704060
050220	230210	602070	481540	321010	704078
050310	230230	602570	482020	321510	705110
050320	230240	604001	482030	322010	705270
060210	240210	604002	482040	322065	705310
060220	240310	605001	482070	322070	705610
060310	510210	605002	961010	331010	705935
060320	520210	605010	961030	331510	706005
080210	530210	606001	961510	332010	706060
080230	530310	606002	961520	341010	706065
080240	550110	606003	961530	341071	707310
080270	550116	607001	962010	341073	708410
080310	550140	607002	962020	341510	708510
080340	550210	607010	962030	341571	709165
080370	550216	607011	962040	341573	
110210	550240	608009		342010	
120210	550310	608010		342065	
130210	550316	608011	<b>CARVING INSERT</b>	342071	<b>ONLAY</b>
140210	550340	609001	490122/806000	342073	801001
150220	560210	609003	490122/807000	351071	801002
150320	560222	609004	490135/806000	351581	801003
160210	570230	901001	490135/807000	352071	802001
160310		901002	490165/806000		802002
180110		901003	490165/807000		802003
180115		901005	490170/806000		803001
180140		901006	490170/807000		803002
180210		901009	490178/806000		803003
180215		902001	490178/807000		804001
180240		902002			804002
190210		902022			804003
190310		902070			805001
190210		902078			805002
190310		907570			828410

# 12-38 specialty mouldings

## Enkeboll

All items are stocked in Alder, Cherry and Hard Maple.  
 Non-stock Woods: Black Walnut, Mahogany, Hickory, Red and White Oak (Premium upcharges)  
**NOTE:** Enkeboll reserves the right to make design modifications without previous notice.

APRON	ARCHES	DRAWER FRONTS	CORBELS	CORBELS	CORBELS
APR-YW1	ARC-EL6	DRF-LO3	CBL-GN1	CBL-SB3	CBL-AAC-PI-0436
APR-YW2	ARC-OL3	DRF-AMA-XX-3XXX	CBL-GN2	CBL-ST1	CBL-AAC-PI-0322
APR-VE3	ARC-SL2		CBL-GP1	CBL-ST2	CBL-AAC-PI-0214
APR-VE5	ARC-SL3		CBL-GP2	CBL-AACX	CBL-ARN-PC-0112
APR-IA3	ARC-SL4	<b>CROWNS</b>	CBL-GP3	CBL-AAC0	CBL-ARN-PC-0216
APR-IE4	ARC-PL2	CRW-FO3	CBL-GW2	CBL-AAC1	CBL-ARN-PC-0320
APR-IE8	ARC-PL3	CRW-GO3	CBL-TP1	CBL-AAC2	CBL-ARN-HR-5XXX
APR-GR3	ARC-PL4	CRW-SC3	CBL-TP2	CBL-AAC3	CBL-ARN-HR-6XXX
APR-GE4	ARC-PL5	CRW-AO3	CBL-TB2	CBL-AAC4	CBL-ARN-XX-4XXX
APR-GE8	PLI-PB5	CRW-OO3	CBL-TB3	CBL-LW1	CBL-ARN-XX-5XXX
APR-VNY-EX-XX04	ARX-OL3	CRW-SO3	CBL-TW2	CBL-LW2	CBL-ARN-XX-6XXX
APR-VNY-EX-XX08	ARX-PL3	MLD-LC3	CBL-TX0	CBL-LW3	CBL-ARN-XX-7XXX
APR-AA3	ARX-PL2	CRW-FO5	CBL-TO0	CBL-SN0	CBL-VF2
APR-GA3	PLI-PB3	CRW-GO5	CBL-TO1	CBL-SN1	CBL-VH3
APR-SA3		CRW-SO5	CBL-TO2	CBL-SN2	CBL-VG2
APR-EX4		CRW-AO5	CBL-TO3	CBL-SHL-XX-44XX	CBL-VS1
APR-EX8	<b>KEYS</b>	CRW-OO5	CBL-TO4	CBL-SHL-XX-54XX	CBL-YO1
APR-HA5	KEY-CB3	CRW-SX5	CBL-TM1	CBL-SHL-XX-64XX	CBL-YO2
APR-HF5	KEY-RB3	MLD-LC5	CBL-TN2	CBL-CC2	CBL-YO3
APR-HG5	KEY-CB5	CRW-VT5	CBL-LO1	CBL-MAB-PC-4XXX	CBL-YO4
APR-HO5	KEY-GO5	CRW-VC5	CBL-LO2	CBL-NAB-TW-54XX	
APR-HS5	KEY-SO3		CBL-LO3	CBL-MOX	<b>COLUMNS</b>
APR-HX4	KEY-SO5		CBL-EO3	CBL-MO0	CLM-AF1
APR-HX8	KEY-PLN-CE-6XXX	<b>CORBELS</b>	CBL-DO2	CBL-MO1	CLM-AF2
	KEY-PLN-CE-5XXX	CBL-OO1	CBL-CO3	CBL-MO2	CLM-AF3
	KEY-PLN-CR-6XXX	CBL-OO2	CBL-CO1	CBL-MO3	CLM-AF4
<b>PULLS</b>	KEY-PLN-CR-5XXX	CBL-OO3	CBL-CH1	CBL-MO4	CLM-AF4-4
PUL-VO1	KEY-PLN-OC-6XXX	CBL-OO4	CBL-SO2	CBL-AMA-BL-44XX	CLM-AF4-2
PUL-LV1	KEY-PLN-OC-5XXX	CBL-FO1	CBL-PO1	CBL-AMA-BL-54XX	CLM-AR4
PUL-LC2	KEY-AO3	CBL-FO2	CBL-PO2	CBL-AMA-BL-64XX	CLM-GO3
PUL-GO1	KEY-AO5	CBL-FO3	CBL-PO3	CBL-WEL-XX-6XXX	CLM-PO3
PUL-GP3	KEY-ACA-CE-5XXX	CBL-RO1	CBL-PO4	CBL-AMA-PC-X4XX	CLM-FP1
PUL-AO1	KEY-ACA-CR-5XXX	CBL-RO2	CBL-PW2	CBL-AMA-PC-XXXX	CLM-FP2
PUL-AO3	KEY-ACA-OC-5XXX	CBL-RO3	CBL-AAX	CBL-AMA-PI-4XXX	CLM-FP3
PUL-SO1	KEY-ACA-CE-6XXX	CBL-RO4	CBL-AA0	CBL-AMA-PI-5XXX	CLM-FP4
PUL-SO3	KEY-ACA-CR-6XXX	CBL-GO1	CBL-AA1	CBL-AMA-PI-6XXX	CLM-FD3
PUL-DR0	KEY-ACA-OC-6XXX	CBL-GO2	CBL-AA2	CBL-AMA-PI-7XXX	CLM-FD4
PUL-GR0	KEY-VS5	CBL-GO3	CBL-AA3	CBL-AMA-XX-56XX	CLM-PP1
PUL-RR0	KEY-AMA-XX-5XXX	CBL-GO4	CBL-AA4	CBL-RP2	CLM-PP2
PUL-SR0		CBL-GB2	CBL-SB1	CBL-RP3	CLM-PP3
		CBL-GN0	CBL-SB2	CBL--RP4	CLM-PP4

MTL-All items are stocked in Alder, Cherry and Hard Maple.  
Non-stock Woods: Black Walnut, Mahogany, Hickory, Red and White Oak (Premium upcharges)  
**NOTE:** Enkeboll reserves the right to make design modifications without previous notice.

COLUMNS	POSTS	POSTS	MANTELS	MANTELS
CLM-PP6	PST-GC8	PST-PC5	MTL-AMF	BAS-IO9
CLM-PD3	FOT-GR1	PST-SB5	MTL-AAF	BAS-ARN-XX-3X42
CLM-PD4	FOT-GR2	PST-ST5	BAS-RO3	MTL-FF7
CLM-PR4	FOT-IR1	PST-MAB-TW-4XXX	BAS-AMA-XX-3X35	MTL-OF7
CLM-FS4	FOT-SR1	PST-MAB-TW-5XXX	BAS-AMA-XX-3X42	MTL-SF7
CLM-PB4	LEG-GO3	PST-PLN-TW-XX45	BAS-RH9	MT-ARN-FC-7X85
CLM-ARX	LEG-GR3	PST-BRD-RD-XX34	BAS-RH3	MTL-PF7
CLM-ALX	LEG-IO3	PST-WO6	HED-LO3	MTL-RF7
CLM-AOX	LEG-SO3	PST-AMA-WL-5XXX	BAS-TO3	MTL-EF4
CLM-FLU-RD-4X52	PST-IC3	FOT-AMA-RD-XXXX	BAS-GO2	MTL-EF8
CLM-ACA-RD-4XXX	PST-IC4	LEG-AMA-CR-XXXX	BAS-GO3	MTL-FIL
CLM-FLU-RD-5X52	PST-IC8	PST-AAT-WL-5XXX	BAS-AD9	MTL-TF8
CLM-ACA-RD-5XXX	PST-IF8	PST-AAT-CE-5XXX	BAS-CL3	MTL-ET8
CLM-FLU-RD-6X52	PST-SP2	PST-AA1	BAS-CC9	MTL-AMA-FC-7X85
CLM-ACA-RD-6XXX	PST-SP3	PST-AA2	BAS-SO3	MTL-AMA-FE-7X04
CLM-AMA-SQ-6X52	PST-SC3	PST-AA3	BAS-LO3	MTL-AMA-AF-7X85
CLM-AMG-SQ-6x52	PST-SC4	PST-AA4	BAS-LO4	MTL-AMA-AE-7X04
CLM-RO3	PST-YC4	PST-AMA-CR-4XXX	BAS-DO3	MTL-VE7
CLM-RR3	PST-YF8	PST-AMA-CR-5XXX	BAS-DO9	MTL-VLL-EX-XX08
CLM-PR3	FOT-YR1	PST-AMA-CR-6XXX	HED-LO4	MTL-VLL-EX-XX04
CLM-AA3	LEG-YO3		PLI-OO6	MTL-YO5
	PST-YP2		BAS-AO9	MTL-ARN-FC-6X52
	PST-YP3	<b>MANTELS</b>	BAS-AR9	MTL-PLN-FE-X408
<b>POSTS</b>	PST-ARN-WL-4XXX	MTL-CHM	BAS-AL9	MTL-PLN-FE-X404
PST-AP2	PST-ARN-WL-5XXX	MTL-COM	BAS-AL3	PLI-002
PST-AP3	FOT-ARN-RD-XXXX	MTL-LLM	BAS-AR3	PLI-006
PST-AC3	LEG-ARN-CR-XXXX	MTL-GOF	HED-BLK	BCK-SP1
PST-AC4	PST-ARN-RD-XX34	MTL-SWF	BAS-AO3	BCK-SP3
PST-AC8	PST-AN3	MTL-ADM	ONL-AB3	
PST-AF8	LEG-VL4	MTL-FCO	BAS-CR9	<b>STILE &amp; RAIL</b>
LEG-AP3	LEG-VL3	MTL-LMM	BAS-CL9	STL-AR1
FOT-AH1	FOT-VL1	MTL-CL9	BAS-CO9	STL-AR2
LEG-AO3	PST-BAM-WL-XX36	MTL-PTM	BAS-CL4	STL-BT0
PST-GP2	PST-BCL-XX-XX36	MTL-TNO	BAS-CR4	STL-BM1
PST-GP3	PST-RP3	MTL-EOC	BAS-CO4	STL-RR1
BAR-GB1	PST-SC5	MTL-AOM	BAS-HB3	STL-RT1
BAR-GB2	PST-BB5	MTL-DOM	BAS-AP7	STL-BO1
BAR-GP6	PST-HC5	MTL-MO5	BAS-VS2	STL-EA1
PST-GR4	PST-BS5	MTL-PNO	BAS-VE3	STL-LA1
PST-GC3	PST-CT5	MTL-LCM	PLI-VS1	STL-YA2
PST-GC4	PST-EP5	MTL-ANF		

# 12-40 specialty mouldings

## Enkeboll

All items are stocked in Alder, Cherry and Hard Maple.  
 Non-stock Woods: Black Walnut, Mahogany, Hickory, Red and White Oak (Premium upcharges)  
**NOTE:** Enkeboll reserves the right to make design modifications without previous notice.

MOULDING	MOULDING	MOULDING	MOULDING	MOULDING	ROSETTE
MLD-AO3	NWL-AF5	FIN-AO3	MLD-EC6	MLD-YB6	ROS-AR1
MLD-FO3	BLR-GF2	FIN-AO4	MLD-FB6	MLD-YC6	ROS-AR2
MLD-GO3	BLR-GF3	FIN-WO1	MLD-FC6	MLD-YA2	ROS-AR3
MLD-OO3	BLR-GF2PT	FIN-O02	MLD-GB6	MLD-YO3	ROS-AS1
MLD-LO3	BLR-GF3PT	FIN-RO2	MLD-GC6	MLD-YP3	ROS-AS2
MLD-FL3	NWL-GF2	FIN-CO2	MLD-MB6	MLD-ARN-BU-XX08	ROS-AS3
MLD-FL2	NWL-GF5	MLD-PB9	MLD-MC6	MLD-ARN-CW-XX08	ROS-AC1
MLD-GL3	BLR-GO2	MLD-PC9	MLD-OB6	MLD-ARN-BU-9X08	ROS-AC2
MLD-MD3	BLR-GO3	MLD-PT1	MLD-OC6	MLD-ARN-CW-9X08	ROS-AC3
MLD-SW3	BLR-GO2PT	MLD-PT2	MLD-SB6	MLD-ARN-AR-XX08	ROS-AO1
MLD-FL5	BLR-GO3PT	MLD-PT3	MLD-SC6	MLD-ARN-AT-XX08	ROS-AO2
MLD-PL5	NWL-GO3	MLD-BP2	MLD-AB9	MLD-ARN-PC-XX08	ROS-AO3
MLD-CB5	NWL-GO5	MLD-OB3	MLD-AC9	MLD-ARN-TR-XX08	ROS-AM6
MLD-RB3	BLR-PO2	MLD-LT1	MLD-FB9	MLD-AA4	ROS-FL2
MLD-RB5	BLR-PO2PT	MLD-LT2	MLD-FC9	MLD-AMA-XX-3X08	ROS-AM4
MLD-EO1	BLR-PO3	MLD-LT3	MLD-GB9	MLD-AAM-XX-3X08	ROS-FC0
MLD-EO3	BLR-PO3PT	MLD-LA1	MLD-GC9	MLD-AAM-XX-5X08	ROS-FC1
MLD-EO4	BLR-PO5	MLD-LA2	MLD-OB9	MLD-AAM-BU-6X08	ROS-LS1
MLD-DO1	NWL-PO3	MLD-LA3	MLD-OC9	MLD-AAM-CW-6X08	ROS-ST0
MLD-DO2	NWL-PO5	MLD-LC3	MLD-AC7	MLD-AMA-XX-5X08	ROS-ST2
MLD-DO3	NWL-PO7	MLD-LC5	MLD-BA1	MLD-AMA-BU-6X08	ROS-DR1
MLD-AR5	BLR-TF2	MLD-LB3	MLD-BA2	MLD-AMA-CW-6X08	ROS-DR2
MLD-NA5	BLR-TF3	MLD-BO1	MLD-RT1	MLD-AAL-XX-3X08	ROS-YS1
MLD-AD3	NWL-TF3	MLD-BO2	MLD-RT2	MLD-AAL-XX-5X08	ROS-YR1
MLD-AD5	NWL-TF5	MLD-BT0	MLD-NB6	MLD-AAL-BU-6X08	ROS-ARN-RE-5XXX
MLD-AB2	BLR-SF2	MLD-BT1	MLD-NC6	MLD-AAL-CW-6X08	ROS-ARN-RE-4XXX
MLD-AB5	BLR-SF3	MLD-BT2	MLD-NO3	MLD-MAY-XX-5X08	
MLD-GC7	NWL-SF3	MLD-FP3	MLD-DC3	MLD-MAY-XX-3X08	
MLD-FF3	NWL-SF5	MLD-SP3	MLD-DC4	MLD-RC3	
MLD-LV3	BRL-AMA-XX-5XXX	MLD-OP3	MLD-BAM-TR-XX08	MLD-RC5	
MLD-LV5	BRL-AMA-XX-6XXX	MLD-GP3	MLD-WVE-TR-XX08	MLD-MDT-XX-3X08	
MLD-GF5	NWL-ASA-XX-6XXX	MLD-AP3	MLD-VB6	MLD-MDT-XX-5X08	
MLD-CF5	NWL-AMA-XX-7XXX	MLD-RA1	MLD-VC6	MLD-OF3	
MLD-PO3	TRD-CLS-CR-5XXX	MLD-RA2	MLD-VB9	MLD-OF5	
MLD-PC4	BLR-ARN-XX-5XXX	MLD-RA3	MLD-VC9	MLD-WC5	
MLD-PC6	BLR-ARN-XX-6XXX	MLD-RA4	MLD-VL3	MLD-WC3	
LAB-PT2	NWL-ARN-XX-6XXX	MLD-FA2	MLD-VP3	MLD-WEL-XX-5X08	
LAB-PT3	NWL-ARN-XX-7XXX	MLD-FA3	MLD-VH9	MLD-WEL-XX-3X08	
BLR-AF2	FIN-AO0	MLD-AB4	MLD-VH4		
BLR-AF5	FIN-AO1	MLD-AC6	MLD-VR2		
NWL-AF3	FIN-AO2	MLD-EB6	MLD-VR3		



# specialty mouldings 12-41

## Enkeboll

CPL-All items are stocked in Alder, Cherry and Hard Maple.  
 Non-stock Woods: Black Walnut, Mahogany, Hickory, Red and White Oak (Premium upcharges)  
**NOTE:** Enkeboll reserves the right to make design modifications without previous notice.

OVERLAY	OVERLAY	OVERLAY	OVERLAY	PANEL	PANEL
ONL-AH1	ONL-FG5	ONL-RH3	ONL-YH3	PNL-LW3	PNL-YN3
ONL-AH2	ONL-FT0	ONL-RH4	ONL-YO3	PNL-ON2	PNL-YM3
ONL-AH3	ONL-FG3	ONL-RH5	ONL-YO2	PNL-OM2	PNL-YW3
ONL-AH4	ONL-FT1	ONL-SM2	ONL-YO1	PNL-ON3	PNL-AU9
ONL-AH5	ONL-FT2	ONL-SM3	ONL-YC2	PNL-OM3	PNL-AU3
ONL-AH6	ONL-FT3	ONL-SC1	ONL-YP4	PNL-OW3	PNL-AL9
ONL-AT0	ONL-FM2	ONL-SC2	ONL-YM4L	PNL-SN2	PNL-AL3
ONL-AT1	ONL-FP3	ONL-SC3	ONL-YM4R	PNL-SM2	PNL-VNY-XX-76XX
ONL-AT2	ONL-FP4	ONL-SH3	ONL-YT1	PNL-SN3	PNL-ARN-XX-76XX
ONL-AT3	ONL-FP5	ONL-SH4	ONL-YT2	PNL-SM3	PNL-VHR-XX-76XX
ONL-AC1	ONL-FM3	ONL-SH5	ONL-YT3	PNL-SW3	PNL-VFB-XX-76XX
ONL-AC2	ONL-FF3	ONL-SO0	ONL-YM3L	PNL-PS1	PNL-BAM-XX-76XX
ONL-AC3	ONL-GM2	ONL-SO2	ONL-YM3R	PNL-PS2	PNL-PPL-XX-76XX
ONL-AM1	ONL-GM3	ONL-FC0	ONL-YM2L	PNL-WS1	PNL-MAB-RT-76XX
ONL-AM2	ONL-GM4	ONL-CP0	ONL-YM2R	PNL-WS2	PNL-AMA-XX-76XX
ONL-AM3	ONL-GH3	ONL-EL4	ONL-ARN-HO-6XXX	PNL-WS3	PNL-MDT-XX-76XX
ONL-AV0	ONL-GH4	ONL-CH4	ONL-ARN-HO-7XXX	PNL-WS4	PNL-TQ1
ONL-AV2	ONL-GH5	ONL-LH2	ONL-ARN-HO-9XXX	PNL-WS5	PNL-AC1
ONL-AV3	ONL-GO1	ONL-OM2	ONL-ARN-PR-4XXX	PNL-WS6	PNL-PR1
ONL-ET2	ONL-GO2	ONL-OM3	ONL-ARN-PR-5XXX	PNL-WS7	<b>CAPITAL</b>
ONL-ET3	ONL-GO3	ONL-LP4	ONL-ARN-PR-6XXX	PNL-WS8	CPL-CP1
ONL-EH4	ONL-GT1	ONL-OT1	ONL-ARN-MD-4XXX	PNL-GC1	CPL-CP2
ONL-HH4	ONL-GT2	ONL-OT2	ONL-ARN-MD-5XXX	PNL-GC2	CPL-CP3
ONL-EH1	ONL-GT3	ONL-OH4	ONL-ARN-PD-7XXX	PNL-GC3	CPL-CP4
ONL-EH2	ONL-HT3	ONL-CM2	ONL-ARN-MD-6XXX	PNL-GC4	CPL-CS1
ONL-EB3	ONL-HT4	ONL-CO3		PNL-GC5	CPL-CS2
ONL-EB4	ONL-HT5	ONL-DH5	<b>PANEL</b>	PNL-AD9	CPL-CS3
ONL-ES5	ONL-LF1	ONL-VH5	PNL-FN2	PNL-AD3	CPL-CS4
ONL-ES6	ONL-LF2	ONL-VF1	PNL-FM2	PNL-CC2	CPL-CR1
ONL-ES7	ONL-LF3	ONL-VE2	PNL-FN3	PNL-GD4	CPL-CR2
ONL-ES8	ONL-MD2	ONL-VS2	PNL-FM3	PNL-FD4	CPL-CR3
ONL-FH3	ONL-MD4	ONL-VT2	PNL-FW3	PNL-LD4	CPL-CR4
ONL-FH4	ONL-RT1	ONL-VM1	PNL-GN2	PNL-OD4	CPL-IP1
ONL-FH5	ONL-RM2	ONL-VD2	PNL-GM2	PNL-SD4	CPL-IP2
	ONL-RM3	ONL-VE1	PNL-GN3	PNL-AN2	CPL-IP3
		ONL-VB4	PNL-GM3	PNL-AM2	CPL-IP4
		ONL-VH4	PNL-GW3	PNL-AN3	CPL-VP4
		ONL-VL4	PNL-LN2	PNL-AM3	CPL-MR3
		ONL-VW4	PNL-LM2	PNL-AW3	CPL-MS3
		ONL-YH5	PNL-LN3	PNL-YN2	CPL-AMA-SQ-6XXX
		ONL-YH4	PNL-LM3	PNL-YM2	CPL-AMG-SQ-6XXX

# 12-42 specialty mouldings

## White River

All items are stocked in Alder, Cherry and Hard Maple.  
 Non-stock Woods: Black Walnut, Mahogany, Hickory, Red and White Oak (Premium upcharges)  
**NOTE:** White River reserves the right to make design modifications without previous notice.

CROWNS	PANEL MOULDING	PANEL MOULDING	FRIEZE MOULDING	PANEL+CHAIR RAIL	CORNICE MOULDING
MLD5839	MLD5044	MLD5870	FR8920	PM8511	CM69
MLD5840	MLD5946	MLD5872	V21	PM8527	CM70
MLD5842	MLD5948	MLD5874	FR8922	PM8520	CM71
MLD5844	MLD5949	MLD5876	FR8923	PM8528	CM72
MLD5846	MLD5950		FR8940	PM8522	CM73
MLD5848	MLD5952	<b>CORNICE MOULDING</b>	FR8950	PM8529	CM74
MLD5860	MLD5954	CM8801	FR8953	PM8523	CM75
MLD5864	MLD5956	CM8808	FR8954	PM8532	CM76
MLD5864 with MLD6002 insert	MLD5958	LCD8252	FR8955	PM8524	CM77
MLD5866	MLD5960	CM8809	FR8956	PM8535	CM80
MLD5866 with MLD6002 insert	MLD5962	CM8810	FR8957	PM8525	CM81
MLD5867	MLD5966	CM8812	FR8958	PM8526	CM82
MLD5868	MLD5976	CM8820	FR8965	PM8536	CM83
MLD5869	MLD5978	CM8823	FR8966	PM8540	CM84
	MLD5979	CM8825	FR8969	PM8541	CM85
<b>FRIEZE MOULDING</b>	MLD5980	CM8830	FR8960	PM8545	CM91
MLD5900	MLD5982	CM8834	FR8967	PM8546	CM86
MLD5902	MLD5986	CM8838	FR8968	PM8552	CM87
MLD5903	MLD5968	CM8840	FR8970	PM8553	CM88
MLD5905	MLD5970	CM8850	FR8971	PM8555	CM89
MLD5910	MLD5972	CM8852	FR8975	PM8558	CM90
MLD5912	MLD5974	CM8854		PM8557	
MLD5914	MLD5975	CM8856	<b>CASING+CHAIR RAIL</b>	PM8572	<b>BACKBAND</b>
MLD5915	MLD6000	CM8857	CA8320	PM8560	BB15
MLD5916	MLD6006	CM8858	CA8340	PM8561	BB16
MLD5917	MLD6004	CM8859	CA8322	PM8564	BB17
MLD5918	MLD6007	CM8860	CA8342	PM8565	BB18
MLD5020	MLD6002		CA8338	PM8568	CR61
MLD5922	MLD6005	<b>BACKBAND</b>	CA8326	PM8569	CR63-A
MLD5924	MLD6018	BB8108	CA8336		CR64
MLD5926	MLD6020	BB8109	CA8330	<b>CASING+CHAIR RAIL</b>	CR65
MLD5928	MLD6024	BB8110	CA8344	CA30	CR66
MLD5940	MLD6028	BB8111		CA31	CR67
MLD5942	MLD6030	BB8120	<b>BASEBOARD MOULDING</b>	CA33	CR68
<b>PEDIMENT</b>	MLD5792	BB8122	BA8440	CA36	CR69
PED5673	MLD5796	LCD3110	BA8442	CA37	LM90
PED5671	MLD5798	LCD4110	BA8444	CA38	LM91
PED5996	MLD5800	LCD3130	CA8430	CA39	LM92
PED5667	MLD5802	LCD4130	CA8342	CA40	LM93
PED5665	MLD5804	LCD3100	CA8344	CA41	
PED5663		LCD4100			

specialty mouldings 12-43  
White River

All items are stocked in Alder, Cherry and Hard Maple.  
 Non-stock Woods: Black Walnut, Mahogany, Hickory, Red and White Oak (Premium upcharges)  
**NOTE:** White River reserves the right to make design modifications without previous notice.

PANEL MOULDING	CROWN	DENTIL+MODILLION	CASING+CHAIR RAIL	PANEL MOULDING	PANEL MOULDING
PM07	CR802	DE168	CA300	PM480	DS110
PM08	LCD8243	DE169	CA302	PM482	DS111
PM09	LCD8240	DE170	CA322	PM484	BS126
PM10	LCD8246	DE171	CA323	PM485	OS101
PM11	CR800	DE172	CA324	PM486	OS102
PM12	CR820	DE173	CA325	LBR011	QR105
PM14	CR801	MG189	CA326	PM500	
PM20	CR830	MB191	CA327	PM505	<b>BACKBAND</b>
PM22	CR840	MD192	CA328	PM511	BB157
PM22-pl	CR806		CA329	PM520	BB158
PM23-B	CR841	<b>BASE</b>	CA335	PM521	BB159
PM24	CR810	B400	CA342	PM525	BB153
PM25	CR850	B416	CA344	PM526	BB155
PM26	CR860	B401	CA362	PM527	BB156
PM27	CR872	B464	CA363	PM529	
PM28	CR880	B462	CA364	PM530	
PM29	CR862	B403	CA368	PM535	
PM50	CR881	B422	CA380	PM537	
PM52	CR864	B463	CA382	PM538	<b>MANTEL+HEADER</b>
PM54	CR882	B470	CA388	PM539	MM187
PM55	CR866	B469	CA389	PM540	TC140
PM56-B		B468	CA360	PM553	DH190
PM57	<b>COVE</b>	B435	CA390	PM560	TC120
PM58	LCD8249	LCD4209	CA391	PM561	MM195
PM59	CO708	PM597	CA392	PM569	TC150
PM70	LCD8252	CA390	CA393	PM570	DS1x2
PM71	LCD8255	LCD4200	CH610	PM577	DS1x4
PM72	CO701	CA391	CH640	PM580	DS1x6
PM73	CO702	LCD4026	CH650	PM582	DS1x8
PM74	CO703	LCD4216	CH659	PM585	DS1x10
	CO704	PM520	CH689	PM586	DS1x12
<b>BASE + HEADER</b>	CO705	B436	CH690	PM590	CDS1x6
BA42	CO707	LCD4040	CH693	PM593	CDS1x4
BB43-C	CO709	PM553		PM595	
BA44	CO711	LCD4065		PM597	
BA46	CO713	BS126		PM598	
BA47	CO720			RE104	
DH99	CO723			RE107	
	CP730			DS100	

## 12-44 architectural accessories